



MARSHYDRO

VG80

USER MANUAL



The Mars Hydro VG80 is rich in red and blue-violet light that promotes and enriches photosynthesis along with chlorophyll absorption more suitable for rhizomes, tissue cultures, clones, leaf vegetables, flowers, fruits, cucumbers and tomatoes. The VG80 is suitable for a variety of indoor grow applications.



MARSHYDRØ

VG80

USER MANUAL



The Mars Hydro VG80 is rich in red and blue-violet light that promotes and enriches photosynthesis along with chlorophyll absorption more suitable for rhizomes, tissue cultures, clones, leaf vegetables, flowers, fruits, cucumbers and tomatoes. The VG80 is suitable for a variety of indoor grow applications.

Dimensions

Length:	45.28IN / 115CM
Width:	1.97IN / 5CM
Height:	1.22IN / 3.1CM
Weight:	4.63LBS / 2.1KG

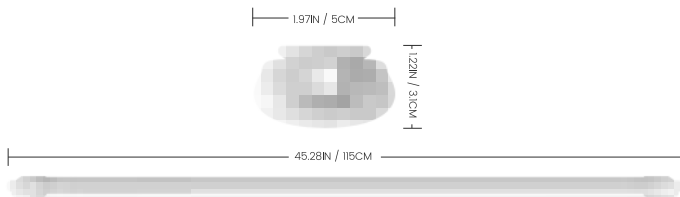

Specifications

Model No:	VG80
Input:	100-277Vac, 80W±5%
Frequency:	50/60HZ
LED Brand:	OSRAM
LED Quantity:	216*2=432PCS
PPF:	155UMOL/S
Spectrum:	4800-5000K,455-465nm,650-665nm
Core Coverage:	4FT*2FT/1.22m*0.61m
IP Rating:	IP65
Working Temperature:	-4~95°F (-20~35°C)
Lifespan:	50,000Hours
Warranty:	5 Year Limited Warranty

Spectrum Test Report

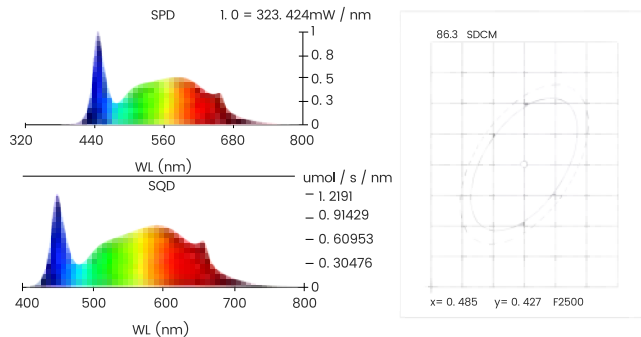

Performance Requirements

AC Voltage	AC Current	AC Power
120V	0.682A	79.68W
240V	0.351A	79.69W
277V	0.315A	80.77W

INCLUDES

Steel Cables (4)	Length Adjusters (4)	Bolts (4)	Clips (4)	AC Power Cord	Light Bar (2)
					

INSTALLATION

(1) Attach the clips to the fixture

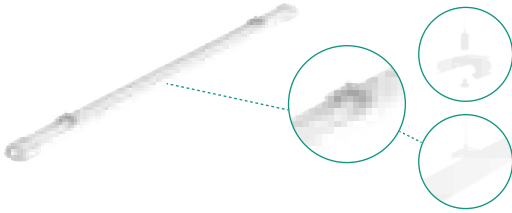

(2) Adjust the position of the clips as needed



(3) Wrap the steel cables over the tent pole or mounting surface

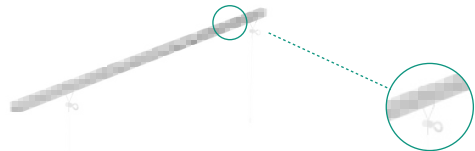

(4) Insert the clip and adjusted end through the loop of the cable .

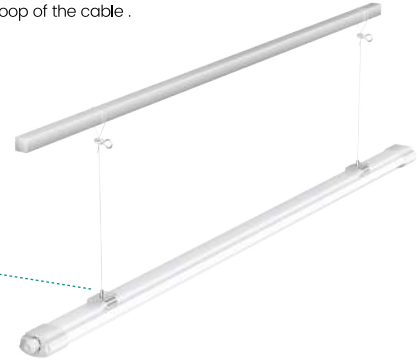
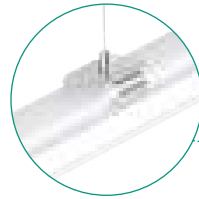

(5) Assembly complete

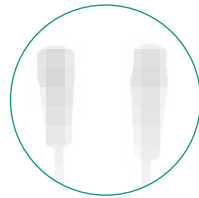

To connect the power cord, align the terminals of the cord, plug in and twist to secure.

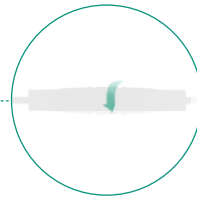
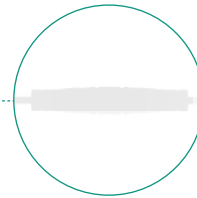

To disconnect the power cord, twist the two halves away from each other first then pull apart.

(6) Up to 10 groups of lights (20 bars) can be connected in series

CAUTION

Do not try to open or disassemble the fixture, it may cause harm to the fixture and void warranty. Do not use the fixtures if the unit has been dropped, and there is damage to the enclosure, power cord or bars. The fixture will get hot during operation. Do not touch while the light is on. Please wait and let the fixture to cool down before handling. Do not touch the LED diodes when the light is on. Keep this fixture away from children.



W: www.mars-hydro.com

E: solutions@mars-hydro.com

T: 1 626 587 8506(US No.)

A: JinTie Industrial Park,
LongGang District,
ShenZhen,518100,China